

User manual Washer-extractors

WB6-50



Electrolux
PROFESSIONAL

Contents

Contents

| | | |
|------|---|----|
| 1 | . Safety precautions..... | 5 |
| 1.1 | Symbols..... | 10 |
| 1.2 | Personal protection equipment..... | 11 |
| 1.3 | Preliminary instructions..... | 11 |
| 1.4 | Data plate explanation..... | 13 |
| 2 | Warranty terms and exclusions..... | 17 |
| 3 | Ergonomics certification..... | 18 |
| 4 | Distributor Letter..... | 19 |
| 5 | Note about the A.C. power..... | 20 |
| 6 | Preparation..... | 20 |
| 6.1 | Loading..... | 20 |
| 6.2 | Detergents..... | 22 |
| 6.3 | Detergent container..... | 23 |
| 6.4 | Maintenance..... | 23 |
| 6.5 | Explanation of accelerometer..... | 23 |
| 7 | Control panel..... | 24 |
| 8 | How to start the machine..... | 26 |
| 9 | Wash programs description..... | 27 |
| 10 | Additional functions..... | 30 |
| 11 | Unloading..... | 31 |
| 11.1 | Unloading side (barrier washer)..... | 31 |
| 11.2 | At the end of the day..... | 33 |
| 12 | Daily maintenance..... | 34 |
| 12.1 | General..... | 34 |
| 12.2 | Every day..... | 34 |
| 12.3 | Detergent container..... | 34 |
| 12.4 | Descaling..... | 34 |
| 12.5 | Maintenance to be carried out by qualified service personnel..... | 34 |
| 13 | Error codes..... | 35 |
| 14 | Lubricant table..... | 36 |
| 15 | Explanation of washing symbols..... | 37 |
| 15.1 | Washing..... | 37 |
| 15.2 | Bleaching..... | 37 |
| 15.3 | Drying..... | 38 |
| 15.4 | Ironing..... | 38 |
| 15.5 | Dry or water cleaning..... | 38 |

The manufacturer reserves the right to make changes to design and component specifications.

1 . Safety precautions

This machine should be installed in conformance to the health and safety regulations, and only used in a sufficiently aerated area. Check the instructions before installing or using the machine.



CAUTION



Before any use, remove all the parts from the inner drum necessary to install the machine, please follow these steps

1. Connect compressed air.
2. Remove the panel from the electrical cabinet.
3. Press with a screwdriver on D3B (see picture below).
4. Open the loading door.
5. Open the inner drum doors with precautions, maintain the 2 doors.
6. Get the package and instructions.

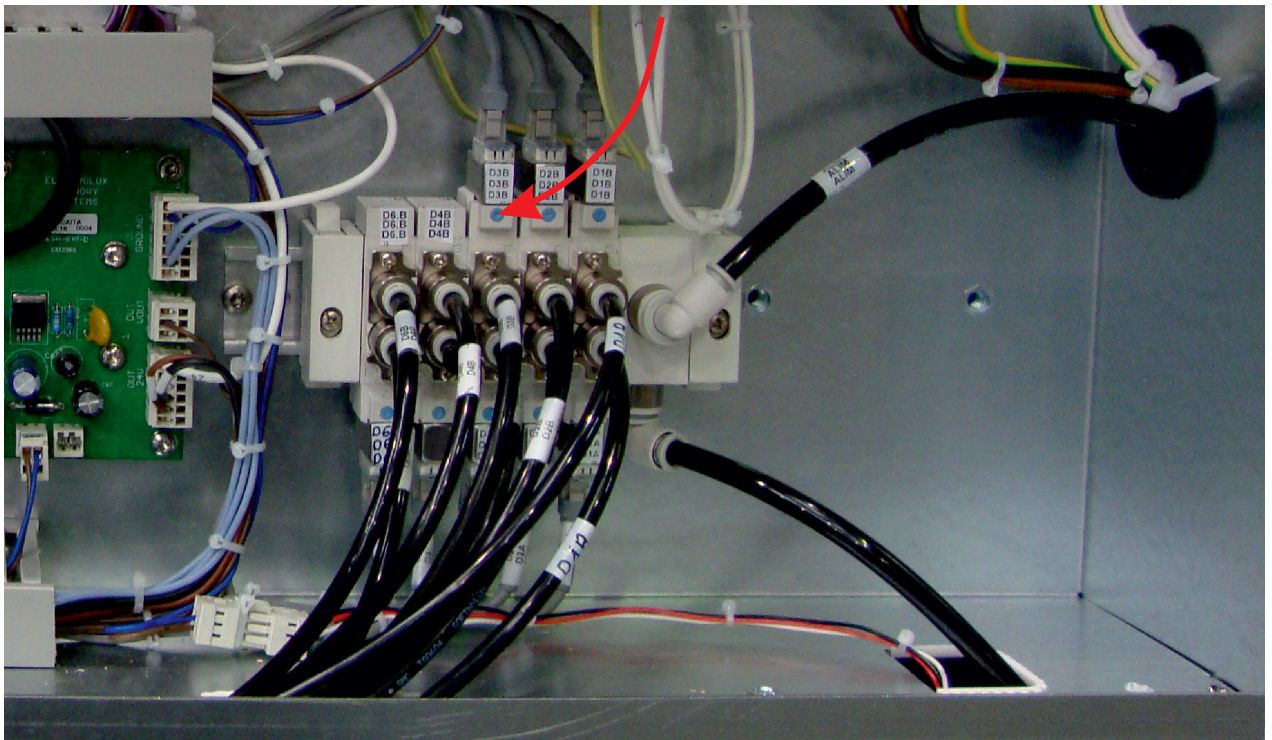



CAUTION



Before any use, it is compulsory to read the instruction handbook.
 Users must have learnt how the machine operates.
 This device must not be installed in places accessible to the public.
 The machine is only intended for water-wash use.
 Do not allow minors to use the machine.
 Do not hose down the machine with water.
 Only use detergent intended for water-wash of textiles Never use dry cleaning agents.
 It is forbidden to wash textiles soaked with solvents.
 The machine's door lock must under no circumstances be bypassed.
 If the machine develops a fault, this must be reported to the person in charge as soon as possible. This is important both for your safety and that of others.
DO NOT MODIFY THIS APPLIANCE.
 Servicing shall be carried out only by authorized personnel.
 Only authorized spare parts shall be used.
 When performing service or replacing parts, the power must be disconnected.
 When the power is disconnected, the operator must see that the machine is disconnected (that the plug is removed and remains removed) from any point to which he has access. If this is not possible, due to the construction or installation of the machine, a disconnection with a locking system in the isolated position shall be provided.
 In accordance with the wiring rules : mount a multi-pole switch prior to the machine to facilitate installation and service operations.
 In order to prevent damage to the electronics (and other parts) that may occur as the result of condensation, the machine should be placed in room temperature for 24 hours before being used for the first time.
 In case of a gas heated machine, do not assemble the machine on premises containing a dry cleaning machines or other similar machines.
 Please wash only items offering appropriate distribution inside the drum. Do not wash items such as mattresses or shoes. Call our technical departments before washing nonstandard items. Noncompliance with these instructions may void the manufacturer's guarantee in case of abuse of the washer-extractor.



CAUTION



For the following countries : AT, BE, BG, HR, CY, CZ, DK, EE, FI, FR, DE, GR, HU, IS, IE, IT, LV, LT, LU, MT, NL, NO, PL, PO, PT, RO, SK, SI, ES, SE, CH, TR, UK : This appliance shall not be installed where the public has access.
 For other countries : This appliance is not intended for use by persons (including children) with reduced physical, sensory or mental capabilities, or lack of experience and knowledge, unless they have been given supervision or instruction concerning use of the appliance by a person responsible for their safety and understand the hazards involved. Children should be supervised to ensure that they do not play with the appliance.

**IMPORTANT**

The identification plate is located on the right side near the main switch.

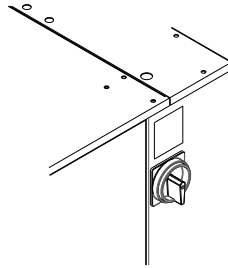

Never use the main switch as an emergency stop. Use it only when the machine does not work in progress. Instead of that, use the emergency stop buttons in both sides of the machine.

**IMPORTANT**

Make sure not to overload the machine. Maximum mass of dry cloth is found in Technical data.
Sound pressure level is found in Technical data.

**IMPORTANT**

Never try to open the outer drum door before the complete stop of the cage.

**CAUTION**

Disconnect all the sources of energy before any intervention on the machine.



The machines comply with the European Directive EMC (Electromagnetic Compatibility). They have been tested in laboratory and approved as such. It is so prohibited to add wires or nonshielded electric cables in the cabinets, strands or cables' troughs. Considering that the volume of the outer drum is superior to 150 litres, the standard kept for the electric part is the IN 60204.

**CAUTION**

With AIDO(Automatic Inner Door Opening) option, Take care of the disc of the opening system above your head. Risk of cutting with the edge of the disc!!

Take care also of the locking system on your side; risk of cutting with the edge of the plate!!

**CAUTION**

When you put your hands into the drum, take care of the edge of the outer drum doors on yours sides. Risk of cutting with the edge of the metal plate!!

**CAUTION**

The machine can work without the protective casing when the electric supply is not cut off.

Interlock the main isolating switch with a padlock.

Close the steam or gas inlet valves.

**IMPORTANT**

Ensure that the machine is not loaded beyond its nominal capacity (see "Specific load" in the instruction booklet's technical characteristics).

An excessive load has consequences for the lifetime of the machine's organs, as follows:

- Rapid destruction of the suspension elements (springs, shock absorbers);
- Excessive fatigue of motorization elements (engine, belt);
- Rapid reduction of lifetime of drum bearings (rolling bearings);
- Opening and destruction of drum doors and tank doors during oil dehydration.

This is particularly important for your safety and that of others.

The consequence is an immediate cancellation of the warranty.



THINK OF THE ENVIRONMENT!



The use and handling of chemical products such as detergent, chlorine, acids, descaling agents, etc may create hazards for health and environment ; the following precautions should be taken:

- Do not breathe the dusts or steam;
- Avoid contact with skin or eyes (may cause burns);
- In case of important spillage, wear a protecting mask, gloves, and eye protectors;
- Handle with care;
- Consult the use and first aid advice on the packing;
- Do not dispose pure products in the environment.



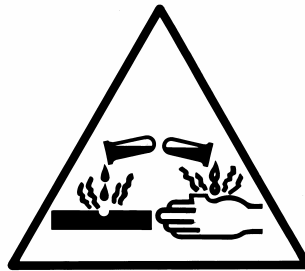

WARNING



The use and handling of chemical products such as detergent, chlorine, acids, antiliming agents etc... may create hazards for health and environment ; the following precautions should be taken.





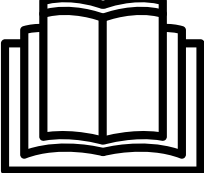

- Do not breathe the dusts or steam.
- Avoid contact with skin or eyes (may cause burns).
- In case of important spillage, wear a protecting mask, gloves, and eye protectors.
- Handle with care.
- Consult the use and first aid advice on the packings.
- Do not dispose pure products in the environment.

1.1 Symbols

| | |
|---|---|
|  | Caution. |
|  | Caution, presence of dangerous current. |
|  | Read the instructions before using the machine. |

1.2 Personal protection equipment

Given below is a summary table of the Personal Protection Equipment (PPE) to be used during the various phases of the machine's service life.

| Phase | Protection garments  | Safety footwear  | Gloves  | Glasses  | Ear protectors  | Mask  | Safety helmet  |
|------------------------|--|--|---|--|---|---|--|
| Transport | | X | O | | | | |
| Handling | | X | O | | | | |
| Unpacking | | X | O | | | | |
| Installation | | X | O | | | | |
| Normal use | X | X | X | X | | | |
| Adjustments | O | X | | | | | |
| Routine cleaning | O | X | X | O | | | |
| Extraordinary cleaning | O | X | X | O | | | |
| Maintenance | O | X | O | | | | |
| Dismantling | O | X | O | | | | |
| Scrapping | O | X | O | | | | |

Legend : X : PPE required ; O : PPE available or to be used if necessary.

Normal use : Safety footwear must be defined for a use on a wet floor. And use glasses and gloves to manipulate chemical products.

1.3 Preliminary instructions



WARNING



Risk of jamming when opening the lower door for unloading



WARNING



Risk of jamming with trolley and lower door when opening (if trolley height = 900mm)

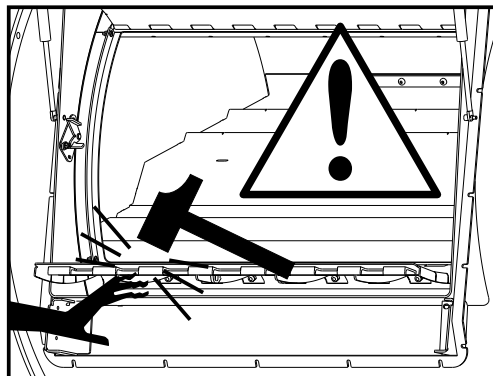

**WARNING**

Risk of the upper door being raised quickly on loading

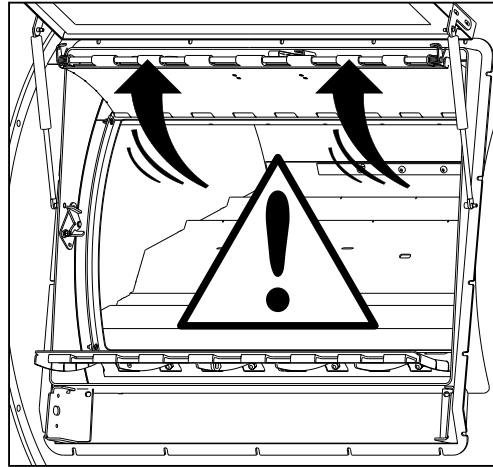
**WARNING**

After the installation, Send back the commissioning form ,signed document, to Electrolux to validate the warranty of the product.

1.4 Data plate explanation

In this chapter, you will find the explanation of the different data input on the data plate of your product.

- Commercial name : Usual name of your product (i.e. WB6–20).
- Type : Type of your product (you have the same on the Declaration of Conformity CE if delivered with CE certification).
- Model : Model of your product (can be different of commercial name) (i.e WSBA6180H17 for commercial name WB6–20) .
- Serial Number : serial number of your product which indicate the week of the production of your product (the first 4 digit indicate the year and the week of production) and the plant where it has been produced (finish by 17)
- Product N°: Product number of your product.
- Date : The date of the end of manufacture of your product
- Capacity : for washer product, the maximum loaded weight of linen for your product (in kg)(i..e. 20 kg for WB6–20)
- Some technical data depending of the heating of your product : see list below :
- Some technical data depending of the voltage ordered.
the voltage looks like that 380–415V 3 50–60Hz
under this, you find the protection request for your product (i.e 16 A)
- Different logos are available on your data plate .
They represent the different certification obtained for your product
CE, EAC
ETL intertek for USA and Canada countries
- QR code : when you scan it, you will be able to obtain the full documentation for your product (Complete installation and user manuals)
- Standardized protection index of your product : IP24D

Electric heating :

- P.Max : maximum power installed of your product
- Power of the motorization in kW and its isolation class (F) .
- Heating power in W .

Commercial name : WHB5500H

Product N° : 9892420151

Serial N° : 3232000817

Type : WS...

Date : 20/07/2023



Electrolux Professional Laundry Systems France 10430 Rosières-près-Troyes - FRANCE



Commercial name : WHB5500H

Type : WS...

Model : WSB5500H17

Serial N° : 3232000817

Product N° : 9892420151

Capacity : 50 kg

P.Max : 42000 W

- kW Isol.Class. : -

36000 W

380-415 V 3 50-60 Hz

63 A



For safety reasons use only original spare parts.



Date : 20/07/2023

Made in France by
Electrolux Professional Laundry Systems France
10430 Rosières-près-Troyes - FRANCE

32101642E



Commercial name : WHB5500H

Product N° : 9892420151

Serial N° : 3232000817

Type : WS...

Date : 20/07/2023



Electrolux Professional Laundry Systems France 10430 Rosières-près-Troyes - FRANCE



Gas heating :

Left side

- P.Max : maximum power installed of your product
- Power of the motorization in kW and its isolation class (F) .
- Heating power in W .
- Gas approval number depending on your machine except ETL product (begin by1312/.....)

Right side

- Qn (Hi) : heating power of your product
- Gas setting in factory : its pressure, its injector diameter and its consumption .
- 3 Other gas type compatible with their pressure, their injectors diameter

Commercial name : WHB5500H
 Product N° : 9892420153
 Serial N° : 4022002617
 Type : WS.... Date : 28/02/2024

Electrolux Professional Laundry Systems France 10430 Rosières-près-Troyes - FRANCE



Commercial name : WHB5500H
 Type : WS....
 Model : WSB5500H17



Serial N° : 4022002617
 Product N° : 9892420153
 Capacity : 50 kg
 P.Max : 6000 W
 5.5 kW Isol.Class. : F
 40 W
 380-415 V 3 50-60 Hz
 16 A

Gas Settings Factory
 Qn(Hi) 40 kW
 Natural Gas, G20 20 mBar, Ø 2,9 mm.
 Mn/Vn 1,3 m3/h
 Type FR.II2Esi3+

Other Gas Options
 Natural Gas, G25 25 mbar Ø 3,2 mm.
 LPG, G30 30 mbar Ø 1,85 mm.
 LPG, G31 37 mbar Ø 1,85 mm.

For safety reasons use only original spare parts.

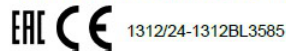

IP24D Date : 28/02/2024

Made in France by
Electrolux Professional Laundry Systems France
10430 Rosières-près-Troyes - FRANCE



32101642E

Commercial name : WHB5500H
 Product N° : 9892420153
 Serial N° : 4022002617
 Type : WS.... Date : 28/02/2024

Electrolux Professional Laundry Systems France 10430 Rosières-près-Troyes - FRANCE



Steam heating :

Left side

- P.Max : maximum power installed of your product
- Power of the motorization in kW and its isolation class (F) .
- Heating power in W .

Right side

- P.Maxi. (kPa) maximum pressure

For additional information, do not hesitate to consult with our quality department.

Commercial name : WHB5500H

Product N° : 9898420006

Serial N° : 1502002317

Type : WS....

Date : 11/02/2022



Electrolux Professional Laundry Systems France 10430 Rosières-près-Troyes - FRANCE



Commercial name : WHB5500H

Type : WS....

Model : WSB5500H17

Serial N° : 1502002317

Product N° : 9898420006

Capacity : 50 kg

P.Max : 6000 W

P. maxi. 600 kPa

5.5 kW Isol.Class. : F



380-415 V 3 50-60 Hz



For safety reasons use only original spare parts.



IP24D Date : 11/02/2022

Made in France by
Electrolux Professional Laundry Systems France
10430 Rosières-près-Troyes - FRANCE



32101642E

Commercial name : WHB5500H

Product N° : 9898420006

Serial N° : 1502002317

Type : WS....

Date : 11/02/2022



Electrolux Professional Laundry Systems France 10430 Rosières-près-Troyes - FRANCE



2 Warranty terms and exclusions

If the purchase of this product includes warranty coverage, warranty is provided in line with local regulations and subject to the product being installed and used for the purposes as designed, and as described within the appropriate equipment documentation.

Warranty will be applicable where the customer has used only genuine spare parts and has performed maintenance in accordance with ElectroluxProfessional user and maintenance documentation made available in paper or electronic format.

ElectroluxProfessional strongly recommends using ElectroluxProfessional approved cleaning, rinse and descaling agents to obtain optimal results and maintain product efficiency over time.

The ElectroluxProfessional warranty does not cover:

- service trips cost to deliver and pick up the product;
- installation;
- training on how to use/operate;
- replacement (and/or supply) of wear and tear parts unless resulting from defects in materials or workmanship reported within one (1) week from the failure;
- correction of external wiring;
- correction of unauthorized repairs as well as any damages, failures and inefficiencies caused by and/or resulting from;
 - insufficient and/or abnormal capacity of the electrical systems (current/voltage/frequency, including spikes and/or outages);
 - inadequate or interrupted water supply, steam, air, gas (including impurities and/or other that does not comply with the technical requirements for each appliance);
 - plumbing parts, components or consumable cleaning products that are not approved by the manufacturer;
 - customer's negligence, misuse, abuse and/or non-compliance with the use and care instructions detailed within the appropriate equipment documentation;
 - improper or poor: installation, repair, maintenance (including tampering, modifications and repairs carried out by third parties not authorized third parties) and modification of safety systems;
 - Use of non-original components (e.g.: consumables, wear and tear, or spare parts);
 - environment conditions provoking thermal (e.g. overheating/freezing) or chemical (e.g. corrosion/oxidation) stress;
 - foreign objects placed in- or connected to- the product;
 - accidents or force majeure;
 - transportation and handling, including scratches, dents, chips, and/or other damage to the finish of the product, unless such damage results from defects in materials or workmanship and is reported within one (1) week of delivery unless otherwise agreed;
- product with original serial numbers that have been removed, altered or cannot be readily determined;
- replacement of light bulbs, filters or any consumable parts;
- any accessories and software not approved or specified by ElectroluxProfessional.

Warranty does not include scheduled maintenance activities (including the parts required for it) or the supply of cleaning agents unless specifically covered within any local agreement, subject to local terms and conditions.

Check on ElectroluxProfessional website the list of authorized customer care.

3 Ergonomics certification

The human body is designed for movement and activity but physical stress injuries as a result of static and repetitive movements or unfavorable working postures may occur.

The ergonomic features of our product, the ones which may influence your physical and cognitive interaction with it, have been assessed and certified.

A product which exhibits ergonomic features, in fact, shall fulfil specific ergonomic requirements, belonging to three different areas: Polytechnic, Biomedical and Psychosocial (usability and satisfaction).

For each of these areas, specific tests with real users have been performed. The product was therefore compliant with the ergonomic acceptability criteria requested by the standards applied.

The product that you use is specifically studied and tested in order to minimise any physical problems associated to the interactions with the product.

The loading and unloading of the linen and the interaction with the product may bring to incongruous postures and to the handling of heavy weights, inherent characteristics of the activity you do we tried to alleviate.

We would like to point out some operating procedures we suggest to adopt:

- Handle the linen in a balanced way, trying not to arch your back during the loading/unloading.
- Take in/out the laundry in small quantities. For example in 20 to 25 times for a WHB5 500, which induces a load of approximately 3 kg with each manipulation.
- In order to avoid the entanglement of laundry including large dishes, add more rotation time in each direction.
- In case of linen entanglement, we advise you to add 30-45s of drain at the end of the program.
- We advise you to use a gripper to catch the laundry at the bottom of the drum. (as picture below)



- If possible, flex your legs and don't bend forward your back during the placement of the linen in the lower box and during the achievement of any lower maintenance actions or items.

- If possible, push the tray cart and pull it in order to reduce the distances.

- Keep the viewing distance in order to understand properly the information displayed in the interface or to view you interest in the drum, reducing as much as possible the time spent with the eyes up (neck extensions).

In case several machines are managed by the same operator the repetitive movements will increase and as a consequence of this the related biomechanical risk will increase exponentially.

Follow the below recommendations to avoid, as much as possible, operators acquiring bodily injury.

- Make sure there are suitable trolleys or baskets for loading, unloading and transportation.
- We advise you to use a mobile bottom trolley with a maximum height of 850mm.
- Organize job rotation in the working place in the case several machines are managed by the same operator.

4 Distributor Letter

Chemical System Responsibility

Disclaimer

The following policy should be considered and understood as a warranty/disclaimer to customers operating textile care installations where liquid supply (chemical) systems use or may use peristaltic pumps to inject supplies into equipment.

To Whom it May Concern:

We, the undersigned, accept no responsibility for loss or damage when, during periods of non-use, concentrated chemicals leak, spray or "dribble" onto any part of our machines or their contents.

It is well known that many pumped liquid chemical systems tend to permit concentrated chemicals to dribble out of the injection tubes when the system has not been used for relatively long periods of time – as after working hours and during weekends. This puts highly concentrated corrosive chemicals in direct contact with dry stainless steel surfaces and often directly on any textiles left in the machine. Chemical deterioration (rusting) of the stainless steel and damage to the textiles is the inevitable result.

It is absolutely useless to flush the affected sites after each injection because the ***harmful dribble always occurs later*** – after the machine is no longer in use. One seemingly foolproof solution for "dribbling chemicals" (which we highly recommend but obviously cannot guarantee) is to locate the chemical tanks and pumps well below the injection point on the machine (so the contents of the injection tube(s) cannot siphon into the machine) and to completely purge the just-used chemical injection tube(s), or manifold, with ***fresh water after every injection*** so that only fresh water (which cannot cause a problem) can dribble out. Naturally, this – or any other solution – is the sole responsibility of the pump and/or chemical supplier (not the machine manufacturer).

Additionally, external chemical leakage is dangerous to personal health and safety, and will also cause severe damage to machines and/or their surroundings. The installer and/or user of the chemical injection system must make sure there are no external chemical leaks and that excessive pressure can never build up in any chemical delivery tube, ***because excessive pressure can burst the tube, or disconnect it from the machine, and spray dangerous concentrated chemicals about the premises***.

The machinery manufacturer is not, and cannot be, responsible for compliance with the above.

5 Note about the A.C. power

According to the EN 60204-1:2018 standard, the machine is provided for A.C. supplies corresponding to the extracted characteristics below :

4.3.2 A.C. supplies

Voltage:

Steady state voltage: from 0.9 to 1.1 of nominal voltage.

Frequency:

from 0.99 to 1.01 of nominal frequency continuously.

from 0.98 to 1.02 short time.

Harmonics:

Harmonic distortion not to exceed 10 % of the total r.m.s. voltage between live conductors for the sum of the second through to the fifth harmonic. An additional 2 % of the total r.m.s. voltage between live conductors for the sum of the sixth through to the 30th harmonic is permissible.

Voltage unbalance:

Neither the voltage of the negative sequence component nor the voltage of the zero sequence component in three-phase supplies shall exceed 2 % of the positive sequence component.

Voltage interruption:

Supply interrupted or at zero voltage for not more than 3 ms at any random time in the supply cycle. There shall be more than 1 second between successive interruptions.

Voltage dips:

Voltage dips shall not exceed 20 % of the peak voltage of the supply for more than one cycle. There shall be more than 1 second between successive dips.

6 Preparation



Important



Sort the linen according to the instructions mentioned on the care labels.
Empty the pockets and clasp the slide fasteners.
Take care to spread the load of laundry and type of laundry evenly in the two compartments.

6.1 Loading

Loading side



Press key "Door unblocking".

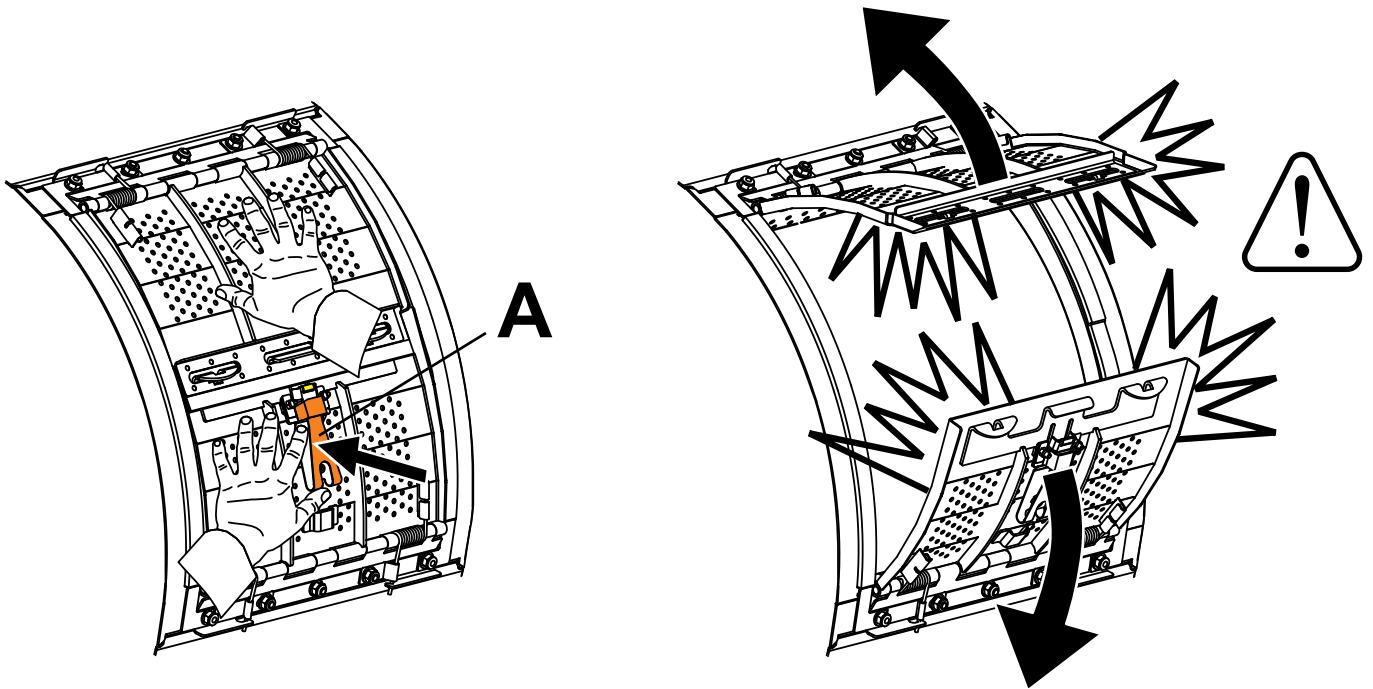

Open the inner drum doors.

Press the safety latch (A) and at the same time on the upper and lower doors with both hands.

Caution, maintain the doors until they are widely open.

Attention, risk of jamming when opening the doors.

Load the linen in the inner drum. Be careful to distribute it correctly.



Caution



Make sure not to overload the machine.

Maximum load (1/10)

| | |
|---------------|---------------------------------|
| WH5500 | 50 kg = 2 x 25kg by compartment |
|---------------|---------------------------------|



Caution



With AIDO(Automatic Inner Door Opening) option, Take care of the disc of the opening system above your head. Risk of cutting with the edge of the disc!!

Note!

Washing in nets

You must note, that it is better to use several nets, three or four in the same compartment rather than one or two. More over, you should finish your load using loose linen if necessary. Divide the number of threads in the two compartments.

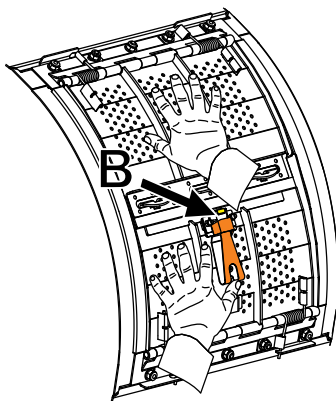

Close the inner drum doors and press them to check the good working of the mechanical safety device (B).

If doors are not properly closed, they might open during a washing cycle and strongly damage the machine.

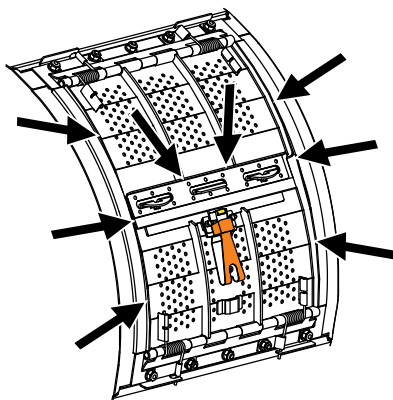

Check that no piece of linen is wedged between the doors and the inner drum.

Close the outer drum door and lock it with the handle. The machine is now ready to start the washing cycle.

6.2 Detergents

Add the correct amount of detergent and softener according to recommendations.



Warning



Take care when adding laundry products. Powder or liquids left in the compartments (scoops) may be corrosive.





Caution



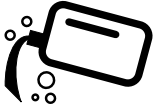

Do not open the cover when the water valves are flushing water through the detergent dispenser. Take care when adding laundry products.

6.3 Detergent container

The detergent container has five compartments. Each compartment is connected to a water valve. The water supply to individual compartment is as follows :

| | |
|---|---|
|  | Softener, liquid. |
|  | Main wash for liquid detergent. Alt. for mop machines, liquid mop chemicals in last rinse. |
|  | Pre-wash, powder or liquid detergent, if option "pre-wash" has been selected. |
|  | Main wash for powder detergent. |

6.4 Maintenance

| | | |
|--|------------------|---|
|  | Important |  |
| <p>Rinse the inside, every days with water, the detergents container. Clean the detergent container at regular basis to avoid that it is being clogged by detergent residue. Clean the detergent container and siphons with hot water and for example a small brush.</p> | | |

6.5 Explanation of accelerometer

The WHB5 appliance has an accelerometer to control the unbalance of the machine during the extraction (spinning) process.

It controls and adjusts speed during spinning process, if the level is not obtain, your linen may be not enough spinned.

In this case, check your loading linen, it must be the same in the two compartments !

And after, select another spinning program.

How does it work?

If the accelerometer detect a problem, then the speed is adjusting and wait several minutes to obtain the right speed. Then, it can increase the speed to the next level. If not , you never obtain the high speed to obtain a good spinning level.

7 Control panel

The control panel is used to choose the wash program with options and to start and stop the machine. The control panel includes a control knob and a display. This control panel also has five preset buttons.

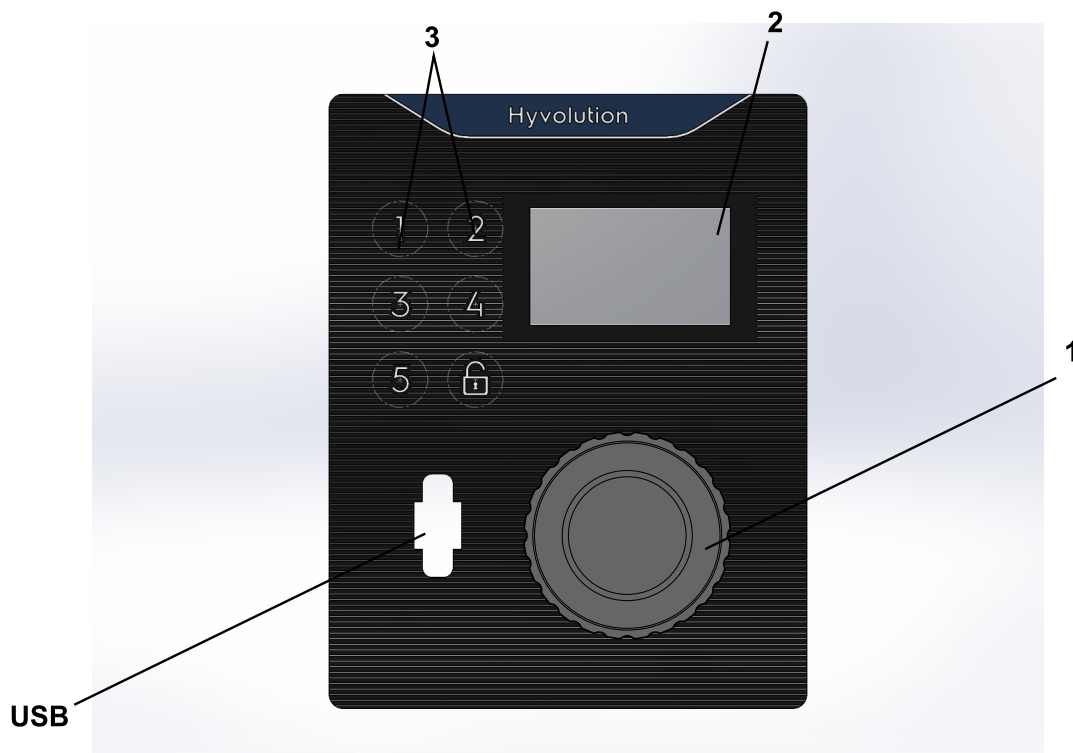

| | |
|---|----------------|
| 1 | Control knob |
| 2 | Display |
| 3 | Preset buttons |

Control knob

The control knob is used to select wash program, options and any other available functions.

Turn the knob until the required option is shown on the display.

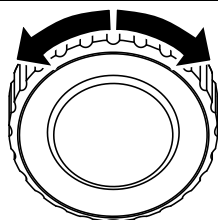

Confirm your choice by pushing in the knob.

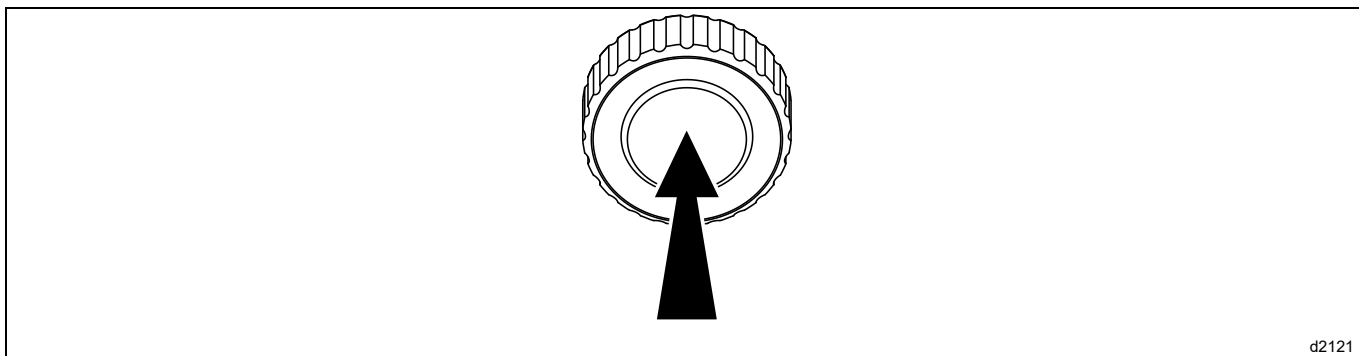

d2121

Repeat this procedure until all the required options have been chosen.

8 How to start the machine









Select the desired program by turning the control knob or select program with the quick selection buttons (if some of the buttons are programmed with this function).

It is possible to select options (if some of the buttons are programmed with this function).

Note!

Some programs do not allow options.

Start the machine by pressing the control knob.

| Example of programs | Example of options programmed in the buttons | |
|---|---|----------------|
| NORMAL  Different temperatures can be selected. 40°C - 95°C. |  | PREWASH |
| MILD  Different temperatures can be selected. 40°C - 60°C. |  | WASH |
| HANDWASH  |  | PRERINSE |
| |  | RINSE |
| |  | RINSE STOP |
| |  | DOOR UNLOCKING |

Buttons

The buttons on the panel can be programmed to be option buttons, quick selection buttons (used to select a program) or both.

At delivery the buttons are programmed to work as options buttons.

The function of the buttons can be changed at any time. Information on how to program the buttons can be found in the Programming and configuration manual and should only be done by a skilled/authorized person.

9 Wash programs description

General

The machine is equipped with a number of programs adapted to the range of use to which the machine is intended. It is recommended to follow the care labelling of the garment as far as possible.



Normal 95 — (3H03)

| | | | | | |
|------------|---------------|-------|-----------|------------|--------------|
| Prewash | No | | | | |
| Mainwash | 8 minutes | 85 °C | Hot water | Low level | Signal 2 & 5 |
| Extraction | 30 seconds | | | | |
| Rinse | 2 x 2 minutes | | | High level | |
| Last rinse | 4 minutes | | | High level | Signal 2 |
| Extraction | 7 minutes | | | | |



Synthetic 40 — (3H03)

| | | | | | |
|------------|---------------|-------|------------|--------------|--------------|
| Prewash | No | | | | |
| Mainwash | 10 minutes | 40 °C | Cold water | Medium level | Signal 2 & 5 |
| Drain | Yes | | | | |
| Rinse | 2 x 2 minutes | | | High level | |
| Last rinse | 4 minutes | | | Medium level | Signal 3 |
| Extraction | 4 minutes | | | | |



Heavy soil 95 — (3H03)

| | | | | | |
|------------|---------------|-------|--------------------|--------------|--------------|
| Prewash | 5 minutes | 60 °C | Hot and cold water | Medium level | Signal 1 |
| Mainwash | 8 minutes | 85 °C | Hot water | Low level | Signal 2 & 5 |
| Extraction | 30 seconds | | | | |
| Rinse | 3 x 2 minutes | | | High level | |
| Last rinse | 3 minutes | | | High level | Signal 3 |
| Extraction | 7 minutes | | | | |



Heavy soil 60 — (3H03)

| | | | | | |
|------------|---------------|-------|--------------------|--------------|--------------|
| Prewash | 5 minutes | 40 °C | Hot and cold water | Medium level | Signal 1 |
| Mainwash | 10 minutes | 60 °C | Hot water | Low level | Signal 2 & 5 |
| Extraction | 30 seconds | | | | |
| Rinse | 3 x 2 minutes | | | High level | |
| Last rinse | 3 minutes | | | High level | Signal 3 |
| Extraction | 7 minutes | | | | |



Normal 70 — (3H03)

| | | | | | |
|------------|---------------|-------|-----------|--------------|--------------|
| Prewash | No | | | | |
| Mainwash | 10 minutes | 74 °C | Hot water | Medium level | Signal 2 & 5 |
| Cool down | 45 °Cs | | | | |
| Drain | Yes | | | | |
| Rinse | 2 x 2 minutes | | | High level | |
| Last rinse | 4 minutes | | | High level | Signal 3 |
| Extraction | 3 minutes | | | | |

**Normal 60 — (3H03)**

| | | | | | |
|------------|---------------|-------|-----------|------------|--------------|
| Prewash | No | | | | |
| Mainwash | 10 minutes | 60 °C | Hot water | Low level | Signal 2 & 5 |
| Extraction | 30 seconds | | | | |
| Rinse | 2 x 2 minutes | | | High level | |
| Last rinse | 4 minutes | | | High level | Signal 3 |
| Extraction | 7 minutes | | | | |

**Delicate 30 — (3H03)**

| | | | | | |
|------------|------------------|-------|------------|------------|----------|
| Prewash | No | | | | |
| Mainwash | 6 minutes | 30 °C | Cold water | High level | Signal 2 |
| Drain | Yes, no rotation | | | | |
| Rinse | 3 minutes | | | High level | |
| Last rinse | 4 minutes | | | High level | Signal 3 |
| Extraction | 1.5 minutes Low | | | | |

**Rinse + Spin — (3H03)**

| | | | | | |
|------------|-----------|--|--|------------|----------|
| Prewash | No | | | | |
| Mainwash | No | | | | |
| Rinse | No | | | | |
| Last rinse | 4 minutes | | | High level | Signal 3 |
| Extraction | 5 minutes | | | | |

**Spin 5 min — (3H03)**

| | | | | | |
|------------|-----------|--|--|--|--|
| Prewash | No | | | | |
| Mainwash | No | | | | |
| Rinse | No | | | | |
| Last rinse | No | | | | |
| Extraction | 5 minutes | | | | |

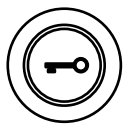
**Clean door opening — (3H03)**

| | | | | | |
|------------|-----------|--|--|--|--|
| Prewash | No | | | | |
| Mainwash | No | | | | |
| Rinse | No | | | | |
| Drain | 5 seconds | | | | |
| Last rinse | No | | | | |
| Extraction | No | | | | |

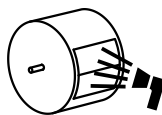
**Descaling — (3H03)**

| | | | | | |
|----------|------------|-------|-----------|-----------|----------|
| Prewash | No | | | | |
| Mainwash | 10 minutes | 75 °C | Hot water | Low level | Signal 1 |

| | | | | | |
|------------|-------------|--|--|------------|----------|
| Drain | 11 secondes | | | | |
| Rinse | 4 minutes | | | High level | Signal 3 |
| Drain | 11 secondes | | | | |
| Extraction | No | | | | |

| Library | 3H03 |
|--------------------|----------------------|
| Compartment 1 | Prewash |
| Compartments 2 & 4 | Mainwash |
| Compartment 3 | Last rinse |
| Signal 1 | Prewash |
| Signal 2 | Mainwash |
| Signal 3 | Softener, last rinse |
| Signal 5 | Bleach, Whitening |

10 Additional functions

Note!

Some of the functions may not be available or active on your machine.

Pause

It is possible to pause an ongoing program.

Press the control knob. A menu will appear on the display. Select **PAUSE** by turning the control knob and press the control knob to activate.

When pressing the control knob again the program will continue.

The door can be opened after a short while if the water level is not too high. Close the door and press the control knob to continue.

Changing a program after start

It is possible to change a program after start.

Press the control knob. A menu will appear on the display. Select **CHANGE PROGRAM** by turning the control knob and press the control knob to activate.

When pressing the control knob the program menu will be displayed. Select a new program and start by pressing the control knob.

Rapid advance

If the machine has this function, it is possible to rapid advance an ongoing program.

Press the control knob. A menu will appear on the display. Select **RAPID ADVANCE** by turning the control knob and press the control knob to activate.

When pressing the control knob a list with all program steps will be displayed. Select desired program step from the list by turning the control knob and press the control knob to activate.

End a program

It is possible to end a program after start.

Press the control knob. A menu will appear on the display. Select **END PROGRAM** by turning the control knob and press the control knob to activate.

When pressing the control knob the program will be ended. When the water is drained the door will be unlocked.

Delayed start

At the beginning of start program, it is possible to delay the start of the program.

After program selection, press the control knob. A menu will appear on the display. Turn the control knob to activate the function. Set the time for the delayed start with the control knob.

Press the control knob to confirm the settings.

Status

Press the control knob. A menu will appear on the display. Select **STATUS MENU** by turning the control knob and press the control knob to activate.

The status menu shows the status for water temperature, water level and drum speed for the machine.

Statistics

Press the control knob. A menu will appear on the display. Select **STATISTICS** by turning the control knob and press the control knob to activate.

The statistics menu shows total run hours and trip run hours for the machine.

Auto restarts

Press the control knob. A menu will appear on the display. Select **AUTO RESTARTS** by turning the control knob and press the control knob to activate.

Set the number of automatic restarts that the machine will perform of the selected program.

Press the control knob to confirm the settings.

11 Unloading

11.1 Unloading side (barrier washer)

At the end of the wash

When a program has finished, the indicating lamp on the clean side will show when the clean side unloading door can be opened.



Caution



With AIDO(Automatic Inner Door Opening) option, Take care of the disc of the opening system above your head. Risk of cutting with the edge of the disc!!

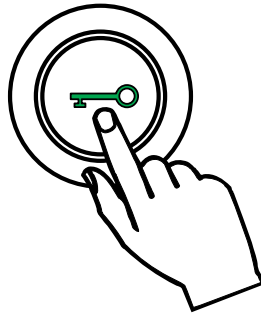

The green key indicator blinks to indicate you can open the outer door.

Push on the "Door unblocking key".

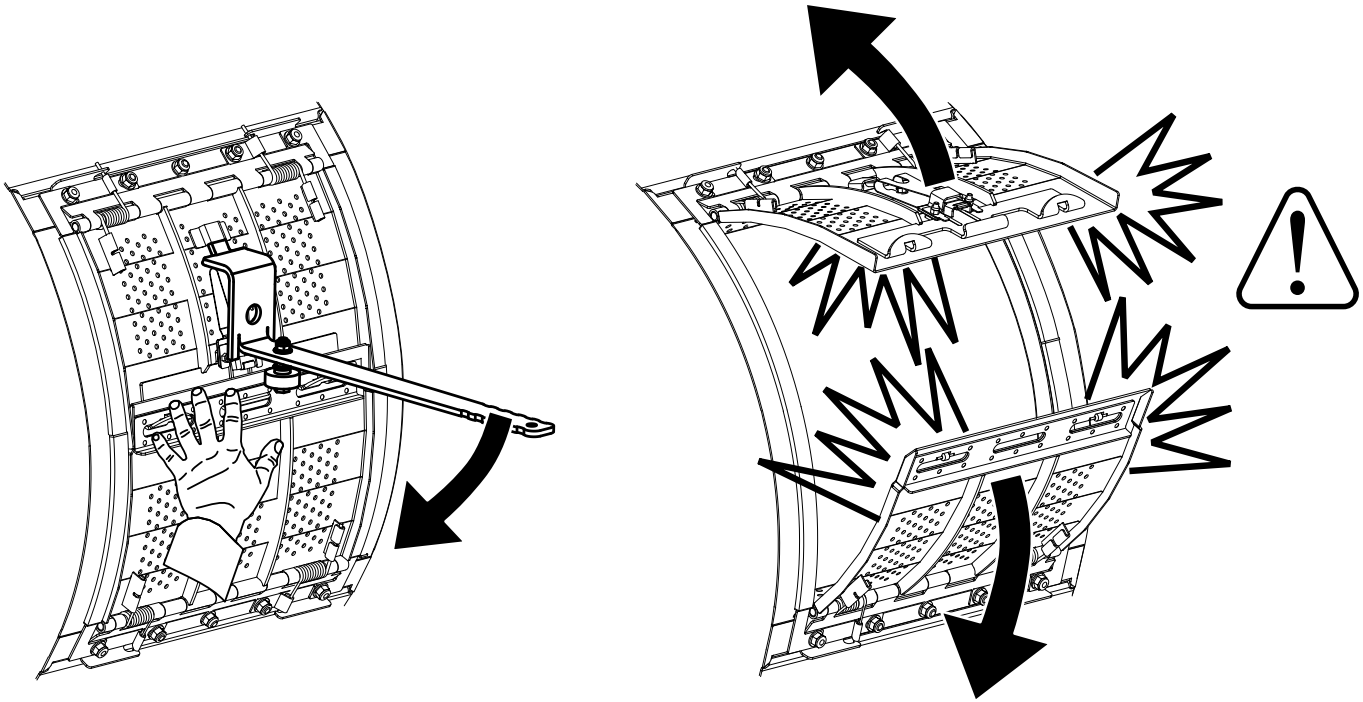

Open the inner doors using the lever.

Caution, maintain the doors until they are widely open.
 Attention, risk of jamming when opening the doors.
 Unload the linen from the inner drum.

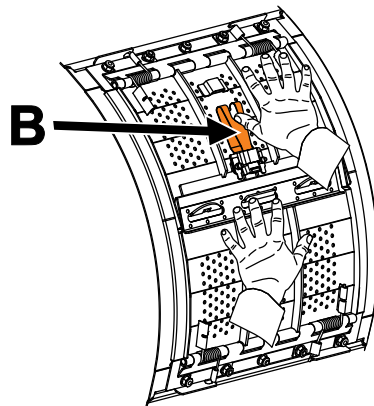

Close the inner drum doors and press them to check the good working of the mechanical safety device (B).

If doors are not properly closed, they might open during a washing cycle and strongly damage the machine.

Close the outer drum door and lock it with the handle.

The clean side unloading door is now locked and the dirty side loading door can be opened.

The clean side unloading door will only unlock when a program has been successfully completed. If the program has been fast forwarded or an error has occurred (no heating, water missing, other errors, etc.) the machine control system will unlock the dirty side loading door. Then the outer loading door has to be opened and closed again and a program has to be run again in order to secure the wash process*.

* This is the case for all programs including sluice programs and rinse + extra programs. Opening the unloading door after a sluice program presents cross contamination issues. The load might not be hygienically clean after only a

sluice program. Therefore it is recommended to add a sluice step to a "normal" program via the option menu when required as opposed to using a sluice program alone.

The machine is now ready for launching a new washing cycle.

11.2 At the end of the day

Leave the door open when ready. This is to prevent that moisture stays in the machine and develop bacteria and mould.

12 Daily maintenance

12.1 General

It is the responsibility of the owner of the machine/the laundry manager to make sure that the following maintenance is performed.

Note!

Lack of maintenance may deteriorate the performance of the machine and may cause damage to components.

Note!

This is recommended time intervals. Depending on the use of the machine other intervals may be necessary.

12.2 Every day

Check that the "emergency stop button" works properly.

Check that the opening safety devices of the drum doors and of the outer doors are working correctly.

Check that the door is locked during a program. Make sure the door cannot be opened until after the program is complete.

If the door can be opened before program end, the machine must be placed out of order until repairs are made.

Check that the door does not leak.

Clean the door, door glass and door gasket.

Clean the external parts.



Warning



Do not clean the washer with bleach or oxygenated water or lubricant (like WD 40 or equivalent) to avoid damaging the logos and the control panel of the machine.
We recommend you to use ECOLAB product to clean the washer.

12.3 Detergent container



Important



Rinse the inside, every days with water, the detergents container.
Clean the detergent container at regular basis to avoid that it is being clogged by detergent residue.
Clean the detergent container and siphons with hot water and for example a small brush.

12.4 Descaling

When descaling is needed:

Use the special machine cleaning program. If it is not available, contact authorized service personnel to get access to the program.

It is also possible to use a program with high temperature , 95 °C, for descaling. Add a descaling agent, for example citric acid.

12.5 Maintenance to be carried out by qualified service personnel

Contact qualified service personnel to perform the following maintenance:

Once a year

- Inspect the interior of the machine during an actual wash cycle to ensure that no leaks are noticed.

Every 3 years

- Replace the gas jacks of each outer doors opening system. (15000 cycles maximum)

13 Error codes

In order to limit the risk of failure in the electronic controls of the programming unit of the machine, the machine should be earthed. Should interferences happen, the first thing to be checked is the earthing of the machine.

A fault in the program or in the machine is indicated by an error code on the display.

Some of these error codes can be solved easily without contacting service personnel.

| Error code | Text | Cause | Action |
|------------|--|--|--|
| 10.16 | EMERGENCY STOP This error code is displayed if the emergency stop switch has been activated on the machine. | <ul style="list-style-type: none"> The cause can be inadvertent activation of the emergency stop, defective emergency stop switch, an electrical connection fault, etc. | <ul style="list-style-type: none"> Check that emergency stop is not activated. If so, release it. |
| 11.1 | WATER FILL TIME OUT When filling with water, the level specified by the program must be attained within a certain time. This time is normally set to 10 minutes but can vary depending on the type of machine and the software. If the filling time exceeds the maximum allowed filling time, this error code will be displayed. | <ul style="list-style-type: none"> Electrovalve's filters are blocked. Long filling times can be caused by a blocked filler valve, defective filler valve, a break in the cable between the filler valve control board, defective valve control board, leaking level system, etc. | <ul style="list-style-type: none"> Clean electrovalve's filters. Check water in main supply. Open taps. Check function of drain valve. Check that level tube is sound and his connection. |
| 11.2 | DOOR OPEN This error code can only arise during an on-going program. | <ul style="list-style-type: none"> Door unlocked. | <ul style="list-style-type: none"> Test whether door really locked. Switch off power to machine. Wait a minute or so, switch on power supply, open and close door again and try restarting. |
| 11.3 | DOOR LOCK FAIL This error code can arise at program start. If the door lock doesn't lock within a certain time after program start, this error code will be displayed. | <ul style="list-style-type: none"> Door position acknowledgement not received in time. This error code will also be displayed if the door switch for locked door signals that the door has been unlocked during an on-going program. | <ul style="list-style-type: none"> Open or close the door. |
| 11.10 | DRAIN TIMEOUT This error code is displayed if the water in the drum is not below a pre-determined level when a drain period has been completed in the program. | <ul style="list-style-type: none"> This error code can be caused by for example a blocked drain, blocked level hose, a water drop in the level hose, defective level control, restricted drain lines to the machine, too many machines emptying simultaneously into drain pipes that are too narrow, etc. | <ul style="list-style-type: none"> Check the drain installation and that the waste water can flow freely out from the machine without any restrictions. Check the drain valve in the machine with regard to dirt. |

For other error codes or repeated error codes, disconnect the power for 30 seconds. If the error code keeps coming back, contact authorized service personnel.

14 Lubricant table

| MACHINE LUBRICATION | | | | | | | | |
|---|-------------------------------|---|--|---|--|---------------------------------|--------------------------------|--------------------------------|
| USES | Rolling bearings Bearings | Rolling bearings Bearings high temperature | Assembly paste (fretting corrosion) | Bare gears Chains shafts Thread Slides | Flange joints Union pipes Steam circuits | Reducers with wheels and screws | Reducers with gears | Circuits and pneumatic devices |
| TYPES OF LUBRICANTS AND STANDARDIZATION | Lithium soap grease | Lithium soap grease + silicone oil | Lithium soap paste + mineral oil + mineral solid greases | Lithium soap grease with MOS2 additive | Graphite grease mini 60% graphite, special leakproof | Extreme high pressure oil | Extreme high pressure oil | Inhibited oil SAE5 |
| | Grade ISO NLGI2 | Grade ISO NLGI3 | Grade ISO NLGI1 | Grade ISO NLGI2 | Grade ISO NLGI2 | Grade ISO VG150 | Grade ISO VG220 | Grade ISO VG22 |
| TEMPERATURE LIMIT RANGE | -20°C + 140°C -4°F + 284°F | -40°C + 200°C -40°F + 392°F | -20°C + 150°C -4°F + 302°F | -20°C + 135°C -4°F + 275°F | -30°C + 700°C -22°F + 1292°F | -0°C + 100°C -32°F + 212°F | -20°C + 120°C -32°F + 248°F | +10°C + 65°C +50°F + 149°F |
| RECOMMENDED | CELTIA G2 | NTN SH44 M | ALTEMP Q NB 50 | MI-SETRAL 43N | GRACO AF 309 | REDUCTELF SP150 | REDUCTELF SP200 | LUBRAK ATL SAE 5W |
| PRODUCT CODE | 96 011 011 | 96 011 019 | 96 011 014 | 96 011 000 | 96 011 004 | 96 010 001 | 96 010 004 | 96 010 030 |
| CORRESPONDENCE | | | | | | | | |
| ANTAR | ROLEXA 2 | | | EPOXA MO2 | | EPONA Z150 | EPONA Z220 | MISOLA AH |
| BP | LS EP2 | | | | | ENERGOL CRXP150 | ENERGOL CRXP220 | SHF 22 |
| CASTROL | SPEEROL EP2 | | | | | ALPHA SP150 | ALPHA SP220 | |
| ELF | EP2 | | | STATERMA MO10 | | REDUCTELF SP150 | REDUCTELF SP220 | SPINEF 22 |
| ESSO | BEACON EP2 | | | MULTI PURPOSE GREASE MOLY | | SPARTAN EP150 | SPARTAN EP220 | SPINESSO 22 |
| FINA | MARSON EP2 | | | | | GIRAN SR150 | GIRAN SR220 | |
| GBSA | | | | | BELLEVILLE N | | | |
| GRAFOIL | | | | | GRACO AF309 | | | |
| KLUBER | CENTOPLEX 2 | UNISILKON L50Z | ALTEMP Q. NB50 | UNIMOLY GL82 | WOLFRA-COAT C | LAMORA 150 | LAMORA 220 | CRUCOLAN 22 |
| MOBIL | MOBILUX | | | | | MOBILGEAR 629 | MOBILGEAR 630 | DTE 24 |
| KERNITE | LUBRA KLC | | | LUBRA KMP | | TOP BLENB ISO 80W90 | TOP BLENB ISO 220 | LUBRA K ATL SAE5W |
| SETRAL | | | | MISETRAL 43N | | | | |
| SHELL | ALVANIA R2 | | | RETINA AM | | OMALA 150 | OMALA 220 | TELLUS 22 |
| TOTAL | MULTISS EP2 | | | | | CARTER AP150 | CARTER EP220 | EQUIVIS 22 |
| MOLYKOTE | | MOLYKOTE 44 | PATE DX | | | | | |
| OPAL | GERVAIR SP | | | SUPER MOS2 | | GEAROPAL GM65 ISO 150 | GEAROPAL GM75 SO 220 | HYDROPAL HO110 HM+ +22 |
| ITECMA | GRL-ULTRA | VULCAIN | SILUB-P | GMO | LHT-C | DURAGEAR BL | DURAGEAR BL | AEROSYN |
| DOW CORNING | | SH 44M | | | | | | |

To lubricate door mechanism of WSB5, use reference 96010068 Loctite LB 8001.















15 Explanation of washing symbols

(ISO 3758:2005 standard)

To overcome language barriers, the following are symbols used internationally to give you guidance and recommendations when washing different textiles.



15.1 Washing

The tub symbolizes washing.

| Symbols | Max. washing temperature in °C (°F) | Mechanical action |
|---|---|-------------------|
|  | 95 (203) | normal |
|  | 95 (203) | mild |
|  | 70 (158) | normal |
|  | 60 (140) | normal |
|  | 60 (140) | mild |
|  | 50 (122) | normal |
|  | 50 (122) | mild |
|  | 40 (104) | normal |
|  | 40 (104) | mild |
|  | 40 (104) | very mild |
|  | 30 (86) | normal |
|  | 30 (86) | mild |
|  | 30 (86) | very mild |
|  | 40 (104) | wash by hand |
|  | - | do not wash |



15.2 Bleaching

The triangle symbolizes bleaching.

| Symbols | Explanation |
|---|---|
|  | Bleaching allowed (chlorine or oxygen). |
|  | Bleaching allowed (only oxygen). |
|  | Do not bleach. |





15.3 Drying

The circle in a square symbolizes tumble drying.

| Symbols | Explanation |
|---|---|
|  | Can be put in a tumble dryer. Normal temperature. |
|  | Can be put in a tumble dryer. Lower temperature. |
|  | Do not put in a tumble dryer. |



15.4 Ironing





The iron symbolizes the domestic ironing and pressing process.

| Symbols | Explanation |
|---|--|
|  | Max. temperature 200 °C. |
|  | Max. temperature 150 °C. |
|  | Max. temperature 110 °C. The steam can cause irreversible damages. |
|  | Do not iron. |

15.5 Dry or water cleaning

The circle symbolizes dry or water cleaning.

| Symbols | Explanation |
|---|--|
|  | Normal dry cleaning with perchloroethyl, solvent of hydrocarb. |
|  | Mild dry cleaning with perchloroethyl, solvent of hydrocarb. |
|  | Normal dry cleaning with solvent of hydrocarbon. |

| | |
|---|--|
|  | Mild dry cleaning with solvent of hydrocarbon. |
|  | Do not dry clean. |
|  | Normal water cleaning. |
|  | Mild water cleaning. |
|  | Very mild water cleaning. |



Electrolux Professional AB
341 80 Ljungby, Sweden
www.electroluxprofessional.com